

PickCap Impression Kit

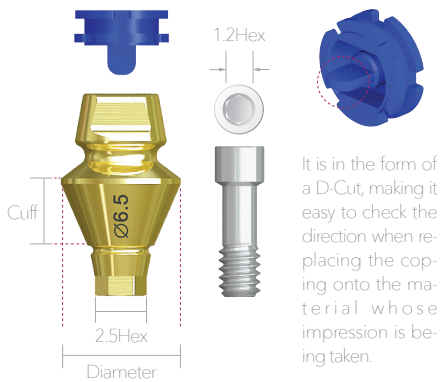

The Pick Cap Impression Kit consists of Impression Copings of various diameters and lengths. It is used to acquire oral impressions conveniently.



Attach a Coping to a Fixture implanted in the oral cavity.



Obtain a bite impression



Attach a Cap to the Coping

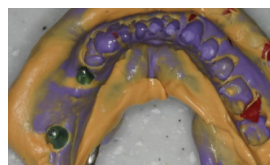

Obtain an impression

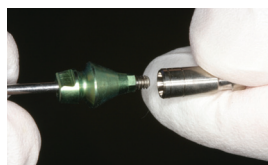

Combine the Coping and the Analog



Reposition the Coping on impression body.

Neo PickCap Impression Kit Tray

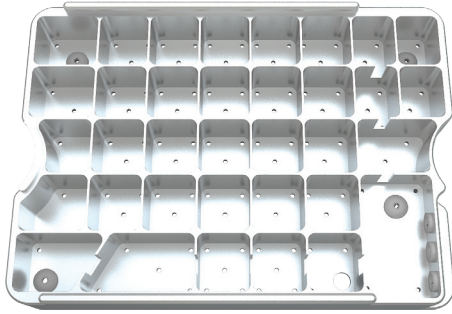



Product Name	PCIKITTRAY
--------------	------------

Neo PickCap Impression Kit Cover







Product Name	PCIKITCOVER
--------------	-------------

Pick Cap Impression Cap

	Product	Product Name	Note
Small Cap		PCISC01	Coping Ø3.5 ~ Ø4.5
Large Cap		PCILC01	Coping Ø5.2 ~ Ø9.0







Positioner & 1.2 Hex Driver

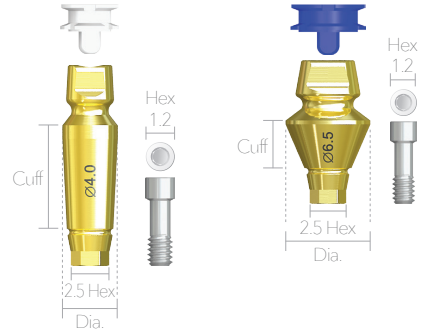

	Product	Product Name	Note
Positioner		AP165N	5 mm
		HD1215	15 mm
1.2 Hex Driver		HD1220	20 mm
		HD1225	25 mm

IS Pick Cap Impression Coping



Diameter	Small Cap		
		Ø3.5	Ø4.0
	3mm	3mm	3mm
			
	5mm	5mm	5mm
			
Cuff (mm)	8mm	8mm	8mm
			
	10mm	10mm	10mm
			

Diameter	Large Cap				
		Ø5.2	Ø5.7	Ø6.5	Ø8.0
	2mm	2mm	2mm	3mm	3mm
					
	3mm	3mm	3mm	4mm	4mm
					
Cuff (mm)	4mm	4mm	4mm		
					
	5mm	5mm	5mm		
					
	6mm	6mm	6mm		
					

Pincette



Product Name	PCIPC
--------------	-------

Neobiotech Co.,Ltd

104, 24 / 102, 103, 104-1, 104-2, 105, 106, 205, 212, 312, 509, 510, 511, 10F,
36 Digital-ro 27-gil, Guro-gu, Seoul, Korea Tel 82-2-582-2885, Fax 82-2-582-2883
www.neobiotech.com / Made in Korea

**Neo
Biotech**
Satisfaction to Dentists